

# Funkenkammer

## zur Visualisierung von kosmischen Myonen

Undergraduate Research Opportunities Program

Dennis Heisler

Fabian Hinder

René Reimann

Simon Weingarten

# Luftschauer

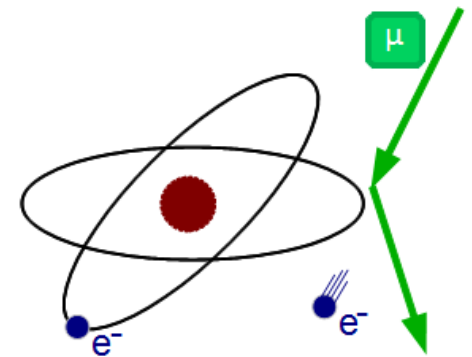
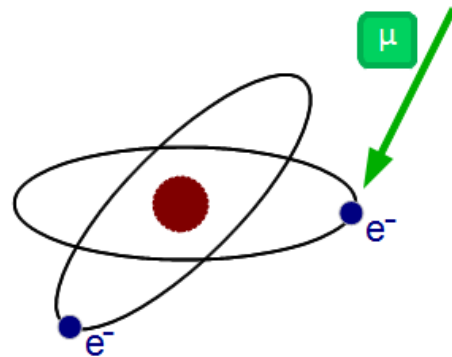
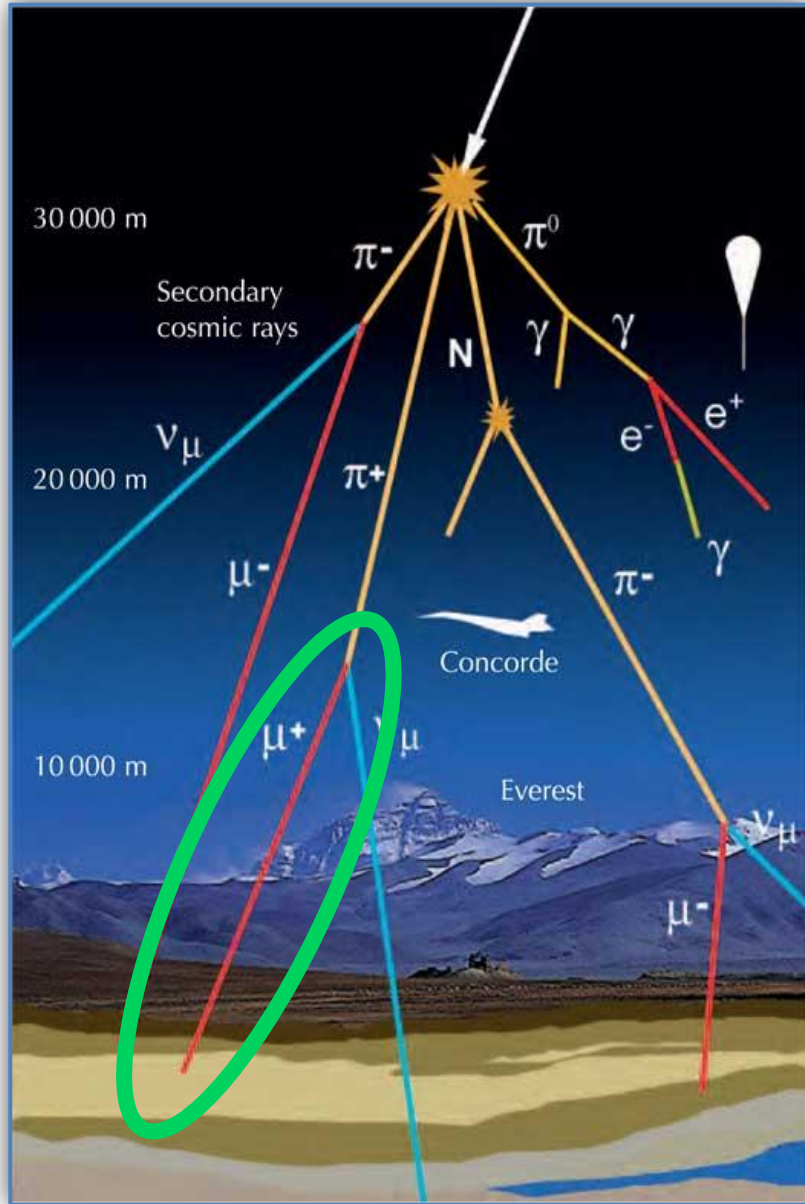

# Funktionsweise

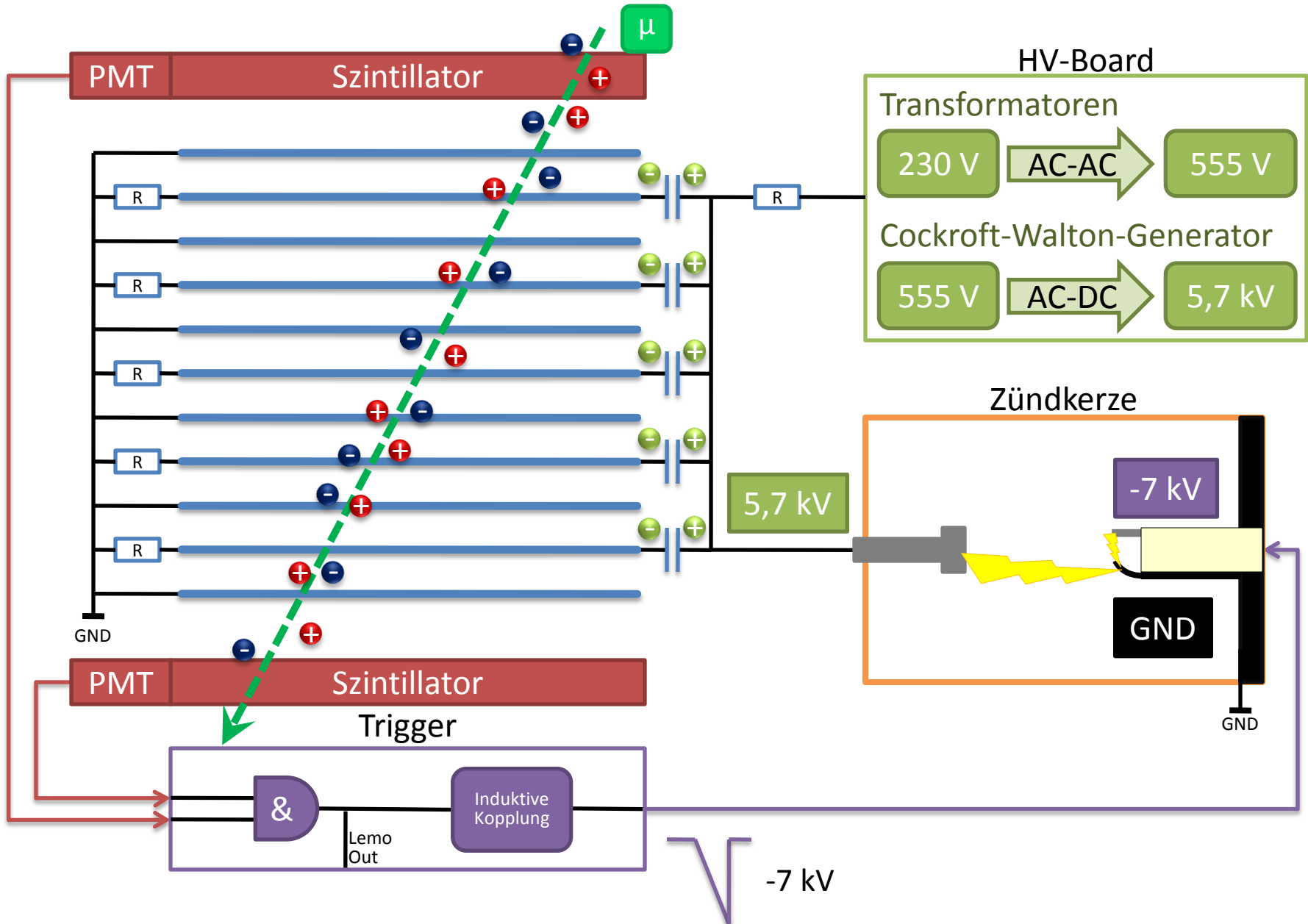

# Detailansichten

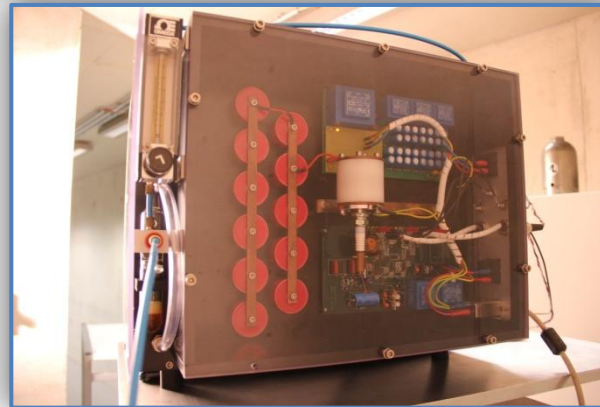
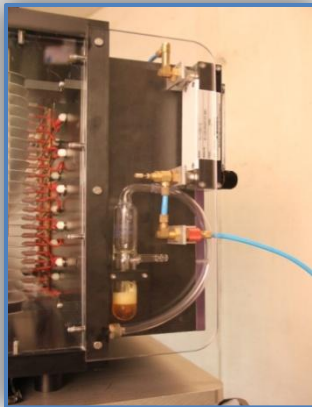
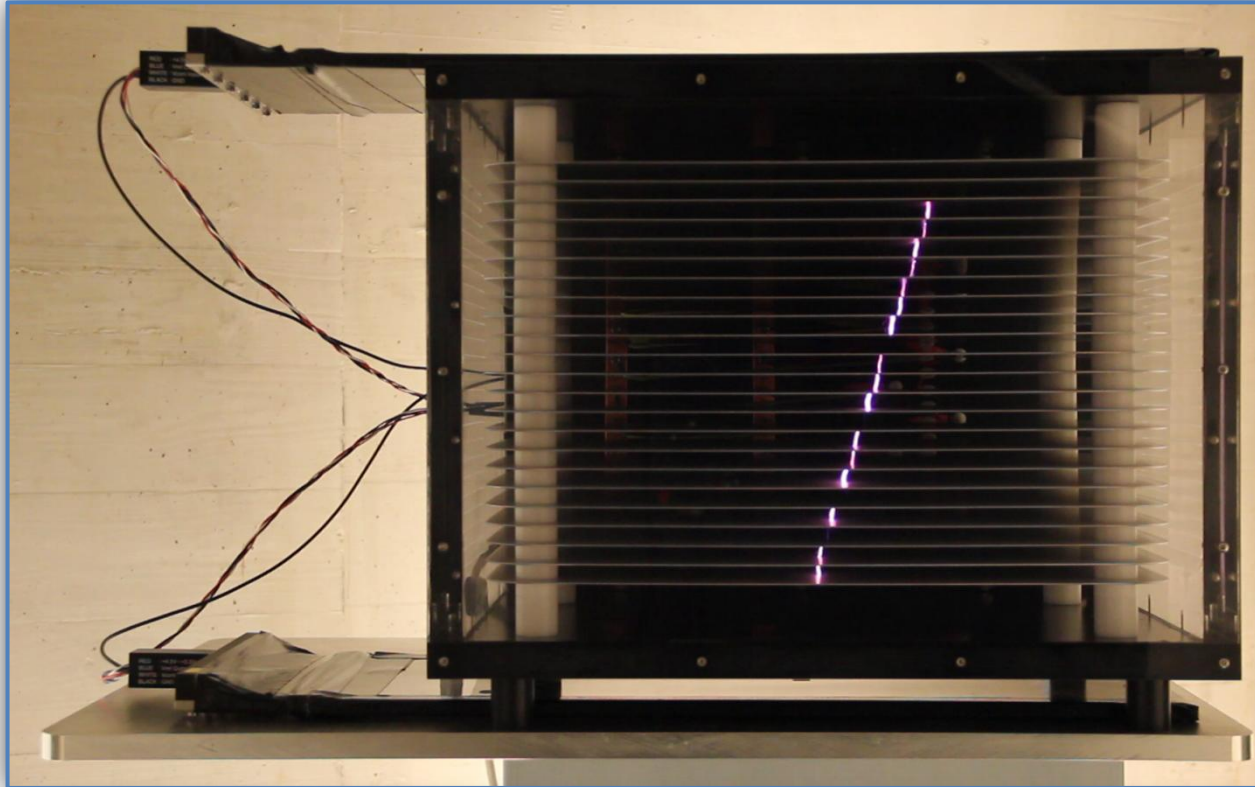

# Sparkfinder

Video

Letzte Spur

Normal

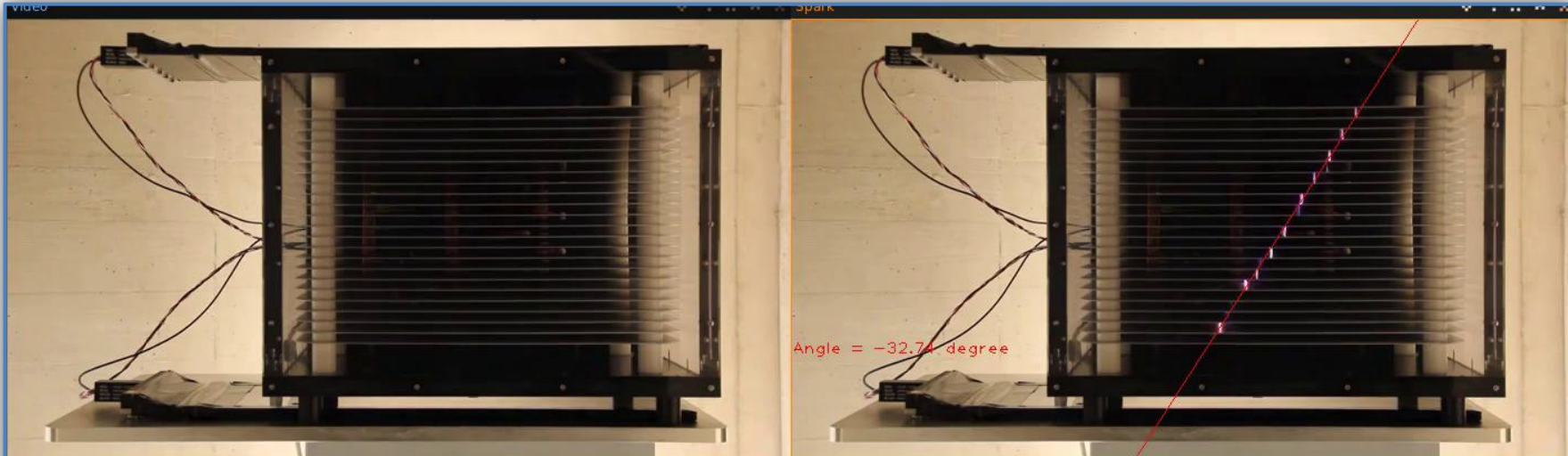

Differenz

